

# FireLock® Check Valves

## Series 717 Check Valve

## Series 717H High Pressure Check Valve



Series 717  
(2½ – 3"/65 – 80 mm)



Series 717  
(4 – 12"/100 – 300 mm)



Series 717H  
High Pressure Check Valve  
(2 – 3"/50 – 80 mm)

### 1.0 PRODUCT DESCRIPTION

#### Available Sizes

- 2 – 3"/DN50 – DN80 (Series 717H)
- 2½ – 12"/DN50 – DN300 (Series 717)

#### Pressure Class

- Up to 365 psi/2517 kPa/25 bar
- Working pressure dependent on size of pipe, valve size and approval requirements.

#### Application

- Designed for use in Fire Protection systems.
- Prevents back flow.
- Single-disc mechanism incorporates a spring-assisted feature for non-slamming operation.
- Can be installed either vertically (flow upwards only) or horizontally.
- Valve body cast with arrow indicator to assist with proper valve orientation.
- Optional upstream and downstream pressure taps included on select sizes. See Section 3.0.
- Provided with grooved ends.
- Rated for ambient temperature use in fire protection systems.

### 2.0 CERTIFICATION/LISTINGS



#### NOTE

- Refer to Victaulic [submittal publication 10.01](#) for details

**ALWAYS REFER TO ANY NOTIFICATIONS AT THE END OF THIS DOCUMENT REGARDING PRODUCT INSTALLATION, MAINTENANCE OR SUPPORT.**

System No.		Location	
Submitted By		Date	

Spec Section		Paragraph	
Approved		Date	

**2.0 CERTIFICATION/LISTINGS (Continued)**

**Approvals/Listings**

Size	Approval/Listing Service Pressures			
	Series 717H			
	cULus	FM	LPCB	Vds
2"/50 mm	365 psi/2517 kPa	365 psi/2517 kPa	365 psi/2517 kPa	365 psi/2517 kPa
2½"/65 mm	365 psi/2517 kPa	365 psi/2517 kPa	365 psi/2517 kPa	365 psi/2517 kPa
76.1 mm	365 psi/2517 kPa	365 psi/2517 kPa	365 psi/2517 kPa	365 psi/2517 kPa
3"/80 mm	365 psi/2517 kPa	365 psi/2517 kPa	365 psi/2517 kPa	365 psi/2517 kPa

Size	Approval/Listing Service Pressures			
	Series 717			
	cULus	FM	LPCB	Vds
2½"/65 mm	250 psi/1725 kPa	n/a	365 psi/2517 kPa	n/a
76.1 mm	250 psi/1725 kPa	n/a	365 psi/2517 kPa	16bar/232 psi
3"/80 mm	250 psi/1725 kPa	n/a	365 psi/2517 kPa	16bar/232 psi
4"/100 mm	365 psi/2517 kPa	365 psi/2517 kPa	365 psi/2517 kPa	16bar/232 psi
5"/125 mm	365 psi/2517 kPa	365 psi/2517 kPa	365 psi/2517 kPa	n/a
139.7 mm	365 psi/2517 kPa	365 psi/2517 kPa	365 psi/2517 kPa	16bar/232 psi
6"/150 mm	365 psi/2517 kPa	365 psi/2517 kPa	365 psi/2517 kPa	16bar/232 psi
165.1 mm	365 psi/2517 kPa	365 psi/2517 kPa	365 psi/2517 kPa	n/a
8"/200 mm	365 psi/2517 kPa	365 psi/2517 kPa	348 psi/2400 kPa	16bar/232 psi
10"/250 mm	250 psi/1725 kPa	250 psi/1725 kPa	1725 kPa/250 psi	n/a
12"/300 mm	250 psi/1725 kPa	250 psi/1725 kPa	1725 kPa/250 psi	n/a

### 3.0 SPECIFICATIONS – MATERIAL

---

**Body:**

Ductile Iron conforming to ASTM A-536, Grade 65-45-12.

**Body Coating:**

Series 717H Body: Black Paint

Series 717H Endface: Electroless Nickel conforming to ASTM B-733

Series 717 (2 ½ – 3"/DN65 – DN80): PPS Coating

Series 717 (4 – 12"/DN100 – DN300): Black Paint

**Body Seat:**

Series 717H: Nitrile O-ring installed into an Electroless Nickel plating conforming to ASTM B-733

Series 717 (2 ½" – 3"/DN65 – DN80): PPS Coated Ductile Iron

Series 717 (4 – 12"/DN100 – DN300): Ductile Iron with Electroless Nickel plating conforming to ASTM B-733

**Disc Seal or Coating: (specify choice<sup>1</sup>)**

**Nitrile (Series 717H only)**

**EPDM**

NOT COMPATIBLE FOR PETROLEUM SERVICES.

**Discs:**

Series 717H: CF8M Cast Stainless Steel

Series 717 (2 ½ – 3"/DN65 – DN80): Aluminum bronze with elastomer seal

Series 717 (4 – 12"/DN100 – DN300): Elastomer encapsulated disc.

**Shaft:**

Series 717H: Brass

Series 717 (2 ½ – 3"/DN65 – DN80): Type 416 Stainless Steel

Series 717 (4 – 12"/DN100 – DN300): Type 316 Stainless Steel

**Spring:**

Type 302/304 Stainless Steel

**Shaft Plug:**

Series 717H: Carbon Steel Zinc Plated

Series 717: Carbon Steel Zinc Plated

**Pipe Plug:**

Series 717H: Carbon Steel Zinc Plated

Series 717: Carbon Steel Zinc Plated

**Optional Pressure Taps:**

Series 717H: Available on all sizes

Series 717: Available on sizes 4 – 12"/DN100 – DN300

## 4.0 DIMENSIONS

### Series 717

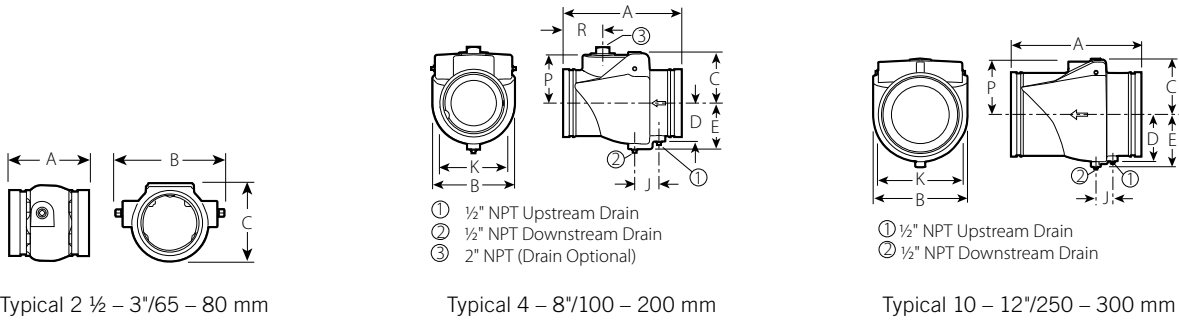

Size		Dimensions									Weight
Nominal inches mm	Actual Outside Diameter inches mm	E to E A inches mm	B inches mm	C inches mm	D inches mm	E inches mm	J inches mm	K inches mm	P inches mm	R inches mm	Approximate (Each) lb kg
2½ 65	2.875 73.0	3.88 99	4.26 108	3.57 91	-	-	-	-	-	-	3.6 1.6
76.1 mm	3.000 76.1	3.88 99	4.26 108	3.57 91	-	-	-	-	-	-	3.6 1.6
3 80	3.500 88.9	4.25 108	5.06 129	4.17 106	-	-	-	-	-	-	4.5 2.0
4 100	4.500 114.3	9.63 245	6.00 152	3.88 99	2.75 70	3.50 89	2.00 51	4.50 114	3.50 89	3.35 85	20.0 9.1
5 125	5.563 141.3	10.50 267	6.80 173	4.50 114	-	4.17 106	2.15 55	5.88 149	4.08 104	3.98 101	27.0 12.3
139.7 mm	5.500 139.7	10.50 267	6.80 173	4.50 114	-	4.17 106	2.15 55	5.88 149	4.08 104	3.98 101	27.0 12.3
6 150	6.625 168.3	11.50 292	8.00 203	5.00 127	-	4.50 114	2.38 61	6.67 169	4.73 120	3.89 99	38.0 17.2
165.1 mm	6.500 165.1	11.50 292	8.00 203	5.00 127	-	4.50 114	2.38 61	6.67 169	4.73 120	3.89 99	38.0 17.2
8 200	8.625 219.1	14.00 356	9.88 251	6.06 154	5.05 128	5.65 144	2.15 55	8.85 225	5.65 144	5.75 146	64.0 29.0
10 250	10.750 273.0	17.00 432	12.00 305	7.09 180	5.96 151	6.69 170	2.15 55	10.92 277	6.73 171	-	100.0 45.4
12 300	12.750 323.9	19.50 495	14.00 356	8.06 205	6.91 176	7.64 194	2.51 64	12.81 925	7.73 196	-	140.0 63.5

## 4.1 DIMENSIONS

### Series 717H

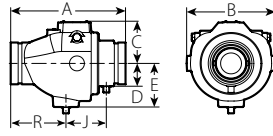

Typical 2<sup>1</sup>/<sub>2</sub> mm – 3<sup>1</sup>/<sub>8</sub> mm

Size	Dimensions									Weight
Nominal inches mm	E to E A inches mm	B inches mm	C inches mm	D inches mm	E inches mm	J inches mm	K inches mm	P inches mm	R inches mm	Approximate (Each) lb kg
2 50	8.66 219.8	6.46 164.1	3.23 82.1	1.48 37.5	3.02 76.7	2.80 71.0	–	–	4.25 108.0	10.7 4.9
2½ 65	9.37 238.0	6.94 176.3	3.31 84.1	1.66 42.2	3.40 86.4	3.38 85.9	–	–	4.38 111.3	13.8 6.3
76.1 mm	9.37 238.0	6.94 176.3	3.31 84.1	1.66 42.2	3.40 86.4	3.38 85.9	–	–	4.38 111.3	13.8 6.3
3 80	9.62 244.3	7.44 189.0	3.53 89.7	1.91 48.5	3.65 92.7	3.38 85.9	–	–	4.63 117.6	20.0 9.1

## 5.0 PERFORMANCE

### Flow Characteristics

The charts below express the flow of water at 60°F/16°C through valve.

#### S717H / 717HR

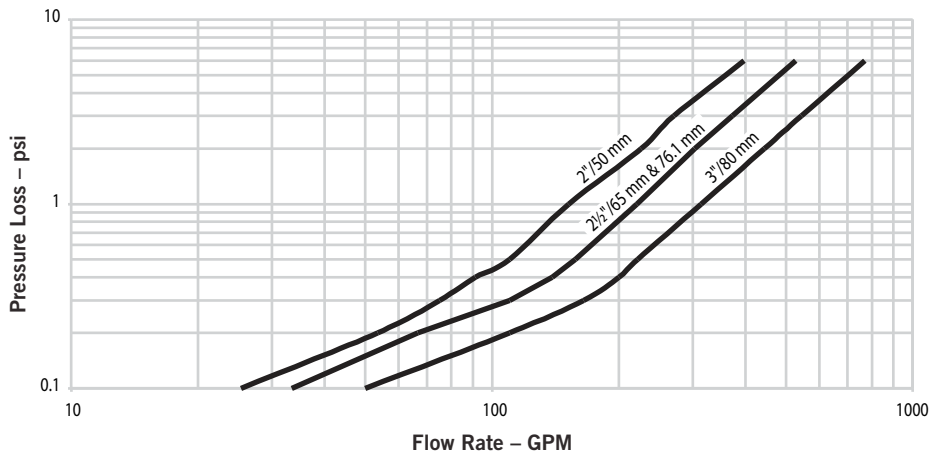

#### S717H / 717HR

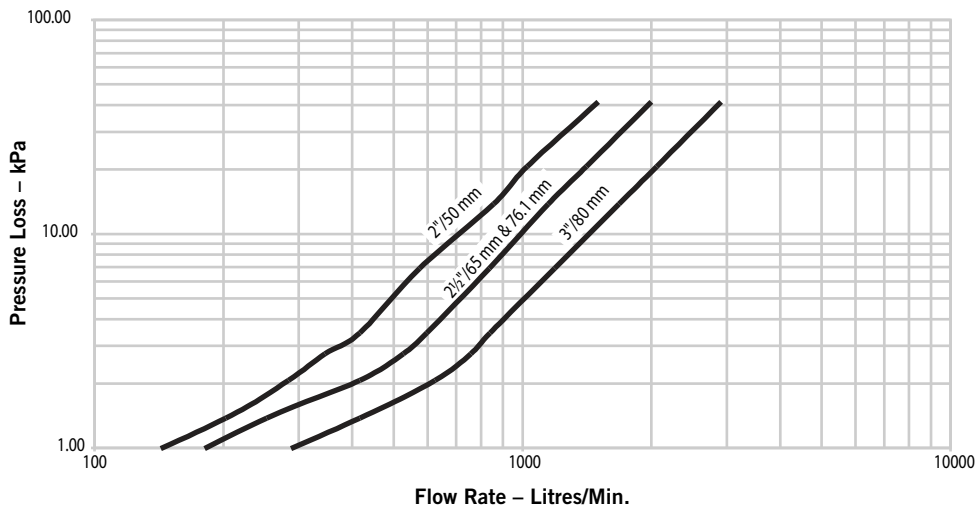

## 5.1 PERFORMANCE

### Flow Characteristics

The charts below express the flow of water at 60°F/16°C through valve.

#### S717 / 717R

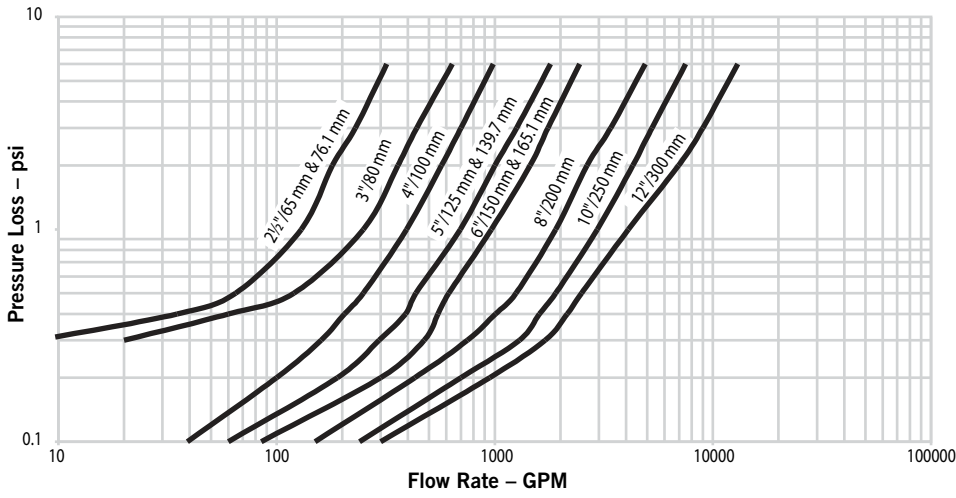

#### S717 / 717R

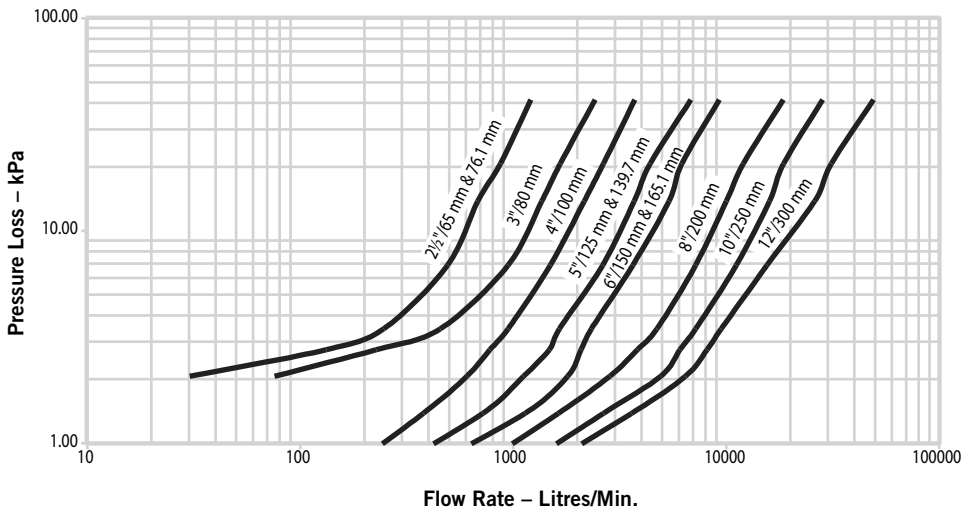

## 6.0 NOTIFICATIONS

### WARNING

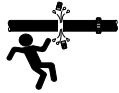

- Depressurize and drain the piping system before attempting to install, remove, adjust, or maintain any Victaulic piping products.

## 7.0 REFERENCE MATERIALS

[05.01: Seal Selection Guide](#)

[10.01: Regulatory Approval Reference Guide](#)

[29.01: Terms and Conditions/Warranty](#)

[I-100: Field Installation Handbook](#)

### User Responsibility for Product Selection and Suitability

Each user bears final responsibility for making a determination as to the suitability of Victaulic products for a particular end-use application, in accordance with industry standards and project specifications, as well as Victaulic performance, maintenance, safety, and warning instructions. Nothing in this or any other document, nor any verbal recommendation, advice, or opinion from any Victaulic employee, shall be deemed to alter, vary, supersede, or waive any provision of Victaulic Company's standard conditions of sale, installation guide, or this disclaimer.

### Intellectual Property Rights

No statement contained herein concerning a possible or suggested use of any material, product, service, or design is intended, or should be construed, to grant any license under any patent or other intellectual property right of Victaulic or any of its subsidiaries or affiliates covering such use or design, or as a recommendation for the use of such material, product, service, or design in the infringement of any patent or other intellectual property right. The terms "Patented" or "Patent Pending" refer to design or utility patents or patent applications for articles and/or methods of use in the United States and/or other countries.

### Note

This product shall be manufactured by Victaulic or to Victaulic specifications. All products to be installed in accordance with current Victaulic installation/assembly instructions. Victaulic reserves the right to change product specifications, designs and standard equipment without notice and without incurring obligations.

### Installation

Reference should always be made to the Victaulic installation handbook or installation instructions of the product you are installing. Handbooks are included with each shipment of Victaulic products, providing complete installation and assembly data, and are available in PDF format on our website at [www.victaulic.com](http://www.victaulic.com).

### Warranty

Refer to the Warranty section of the current Price List or contact Victaulic for details.

### Trademarks

*Victaulic* and all other Victaulic marks are the trademarks or registered trademarks of Victaulic Company, and/or its affiliated entities, in the U.S. and/or other countries.